

# Pallet scale KERN UFB

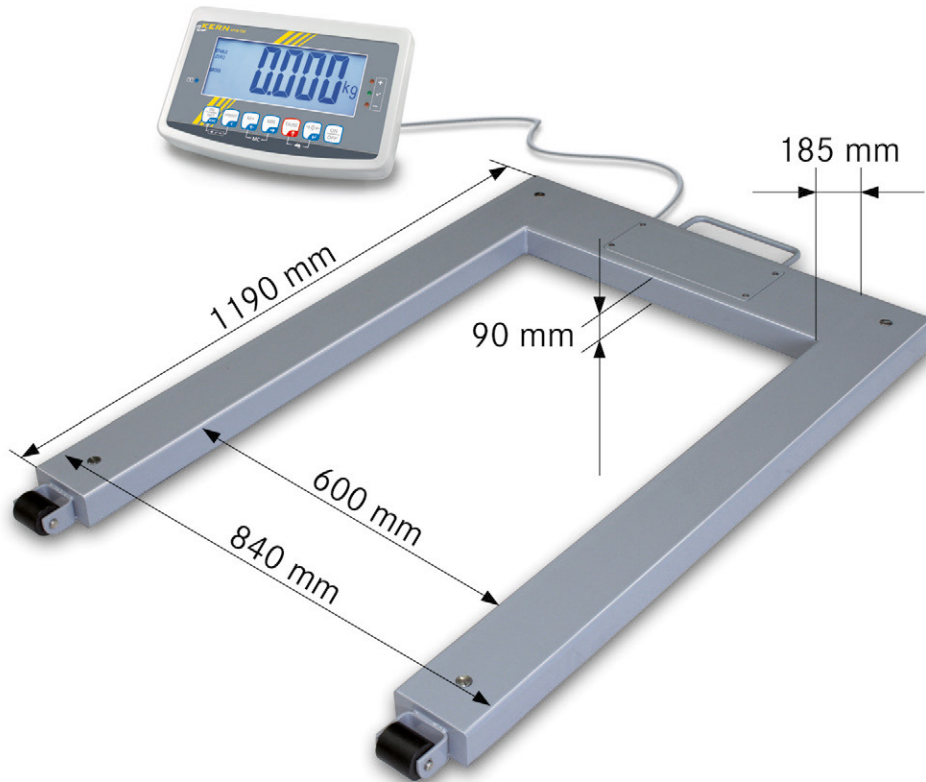

## Mobile pallet scale with EC type approval [M]

### Features

- **High mobility:** thanks to battery operation (optional) and compact, flat construction, it is suitable for use in several locations (production, warehouse, dispatch department etc.)
- **2 rollers and handle** for easy transport of the scale
- **Weighing with tolerance range (check-weighing):** Input of an upper/lower limit value. A visual and audible signal assists with portion division, dispensing or grading or the rapid checking of items on pallets
- **Totalising** of weights
- **4 load cells steel, silicone-coated, IP67**
- **Solid steel construction load support** lacquered, extremely resistant to bending. Also available as component without the display device, KERN KFU-V20, see page 140
- **Display device KERN KFB-TM**, for details see page 134

- A counting scale can be connected using the data interface, and this can be used to create a high-capacity counting system for counting very small parts in largest quantities

### Technical data

- Large backlit LCD display, digit height 52 mm
- Cable length of display device approx. 5 m
- Dimensions of display device WxDxH 250x160x58 mm
- Net weight approx. 43 kg
- Permissible ambient temperature -10 °C / 40 °C

### Accessories

- **Protective working cover** over the display device standard, can be retrofitted, KERN KFB-A02
- **Stand** to elevate display device, height of stand approx. 750 mm, similar to illustration, KERN BFS-A07

Limited tare range with verifiable models (1/6 from [Max])

Shipment via freight forwarder. Please ask for dimensions, gross weight, shipping costs

- **Rechargeable battery pack internal**, operating time up to 35 h, charging time approx. 12 h, must be ordered at purchase, KERN KFB-A01
- **Signal lamp** for visual support of weighing with tolerance range, WxDxH 100x180x300 mm, see page 160, KERN CFS-A03
- **Large display with superior display size**, digit height 76 mm, WxDxH 541x55x180 mm, for details see page 160, KERN YKD-A02
- **Y cable** for parallel connection of two terminal devices to the RS-232 interface on the balance, e.g. signal lamp and printer, KERN CFS-A04
- **Cable with special length 15 m**, between display device and platform, must be ordered at purchase, KERN BFB-A03
- **Suitable printers** see page 157 ff.

### STANDARD



### OPTION



### FACTORY











































3

Model	Weighing range	Readout	Verification value	Minimum load	Options			
					Verification		DAkKS Calibr. Certificate	
					M	KERN	DAkKS	KERN
KERN	[Max] kg	[d] g	[e] g	[Min] kg				
UFB 600K200M	600	200	200	4	965-230		963-130	
UFB 1.5T0.5M	1500	500	500	10	965-230		963-130	

Note: For applications that require verification, please order verification at the same time, initial verification at a later date is not possible. Verification at the factory, we need to know the full address of the location of use.

# KERN Pictograms

 <b>Internal adjusting:</b> Quick setting up of the balance's accuracy with internal adjusting weight (motordriven).	 <b>Recipe level A:</b> Separate memory for the weight of the tare container and the recipe ingredients (net total).	 <b>Suspended weighing:</b> Load support with hook on the underside of the balance.
 <b>Adjusting program CAL:</b> For quick setting up of the balance's accuracy. External adjusting weight required.	 <b>Recipe level B:</b> Internal memory for complete recipes with name and target value of the recipe ingredients. User guidance through display.	 <b>Battery operation:</b> Ready for battery operation. The battery type is specified for each device.
 <b>Memory:</b> Balance memory capacity, e.g. for article data, weighing data, tare weights, PLU etc.	 <b>Recipe level C:</b> Internal memory for complete recipes with name and target value of the recipe ingredients. User guidance through display. Additional convenient functions, such as barcode and back calculation functions.	 <b>Rechargeable battery pack:</b> Rechargeable set.
 <b>Data interface RS-232:</b> To connect the balance to a printer, PC or network.	 <b>Totalising level A:</b> The weights of similar items can be added together and the total can be printed out.	 <b>Mains adapter:</b> 230V/50Hz in standard version for EU. On request GB, AUS or USA version available.
 <b>RS-485 data interface:</b> To connect the balance to a printer, PC or other peripherals. High tolerance against electromagnetic disturbance.	 <b>Totalising level C:</b> Internal memory for complete recipes with name and target value of the recipe ingredients. User guidance through display. Additional convenient functions, such as barcode and back calculation.	 <b>Power supply:</b> Integrated in balance. 230V/50Hz standard EU. More standards e.g. GB, AUS or USA on request.
 <b>USB data interface:</b> To connect the balance to a printer, PC or other peripherals.	 <b>Strain gauges:</b> Electrical resistor on an elastic deforming body.	
 <b>Bluetooth data interface:</b> To transfer data from the balance to a printer, PC or other peripherals.	 <b>Tuning fork principle:</b> A resonating body is electromagnetically excited, causing it to oscillate.	
 <b>WLAN data interface:</b> To transfer data from the balance to a printer, PC or other peripherals.	 <b>Percentage determination:</b> Determining the deviation in % from the target value (100 %).	 <b>Electromagnetic force compensation:</b> Coil inside a permanent magnet. For the most accurate weighings.
 <b>Control outputs (optocoupler, digital I/O):</b> To connect relays, signal lamps, valves, etc.	 <b>Weighing units:</b> Can be switched to e.g. non-metric units at the touch of a key. See balance model. Please refer to KERN's website for more details.	 <b>Single cell technology:</b> Advanced version of the force compensation principle with the highest level of precision.
 <b>Interface for second balance:</b> For direct connection of a second balance.	 <b>Weighing with tolerance range:</b> Upper and lower limiting values can be programmed individually for e.g. dosing, sorting and portioning.	 <b>Verification possible:</b> The time required for verification is specified in the pictogram.
 <b>Network interface:</b> For connecting the scale to an Ethernet network. With KERN products you can use a universal RS-232/LAN converter.	 <b>Vibration-free weighing:</b> (Animal weighing program) When the weighing conditions are unstable, a stable weight is calculated as an average value.	 <b>DAkkS calibration possible:</b> The time required for DAkkS calibration is shown in days in the pictogram.
 <b>GLP/ISO log:</b> The balance displays the weight, date and time, regardless of a printer connection.	 <b>Protection against dust and water splashes IPxx:</b> The type of protection is shown in the pictogram. For details see the glossary.	 <b>Package shipment:</b> The time required for internal shipping preparations is shown in days in the pictogram.
 <b>GLP/ISO log:</b> With weight, date and time. Only with KERN printers, see "Accessories"	 <b>ATEX explosion protection:</b> Suitable for use in hazardous industrial environments, in which there is explosion danger. The ATEX marking is specified for each device.	 <b>Pallet shipment:</b> The time required for internal shipping preparations is shown in days in the pictogram.
 <b>Piece counting:</b> Reference quantities selectable. Display can be switched from piece to weight.	 <b>Stainless steel:</b> The balance is protected against corrosion.	 <b>Warranty:</b> The warranty period is shown in the pictogram.

## Precision is our business

To ensure the high precision of your balance KERN offers you the the appropriate test weight in the international OIML error limit classes E1-M3 from 1 mg - 2000 kg. In combination with a DAkkS calibration certificate the best pre-requisite for proper balance calibration.

The KERN DAkkS calibration laboratory today is one of the most modern and best-equipped DAkkS calibration laboratories for balances, test weights and force-measurement in Europe.

## Your KERN specialist dealer:

Thanks to the high level of automation, we can carry out DAkkS calibration of balances, test weights and force-measuring devices 24 hours a day, 7 days a week.

### Range of services:

- DAkkS calibration of balances with a maximum load of up to 6 t
- DAkkS calibration of weights in the range of 1 mg - 500 kg
- Database supported management of checking equipment and reminder service
- Calibration of force-measuring devices
- DAkkS calibration certificates in the following languages D, GB, F, I, E, NL